

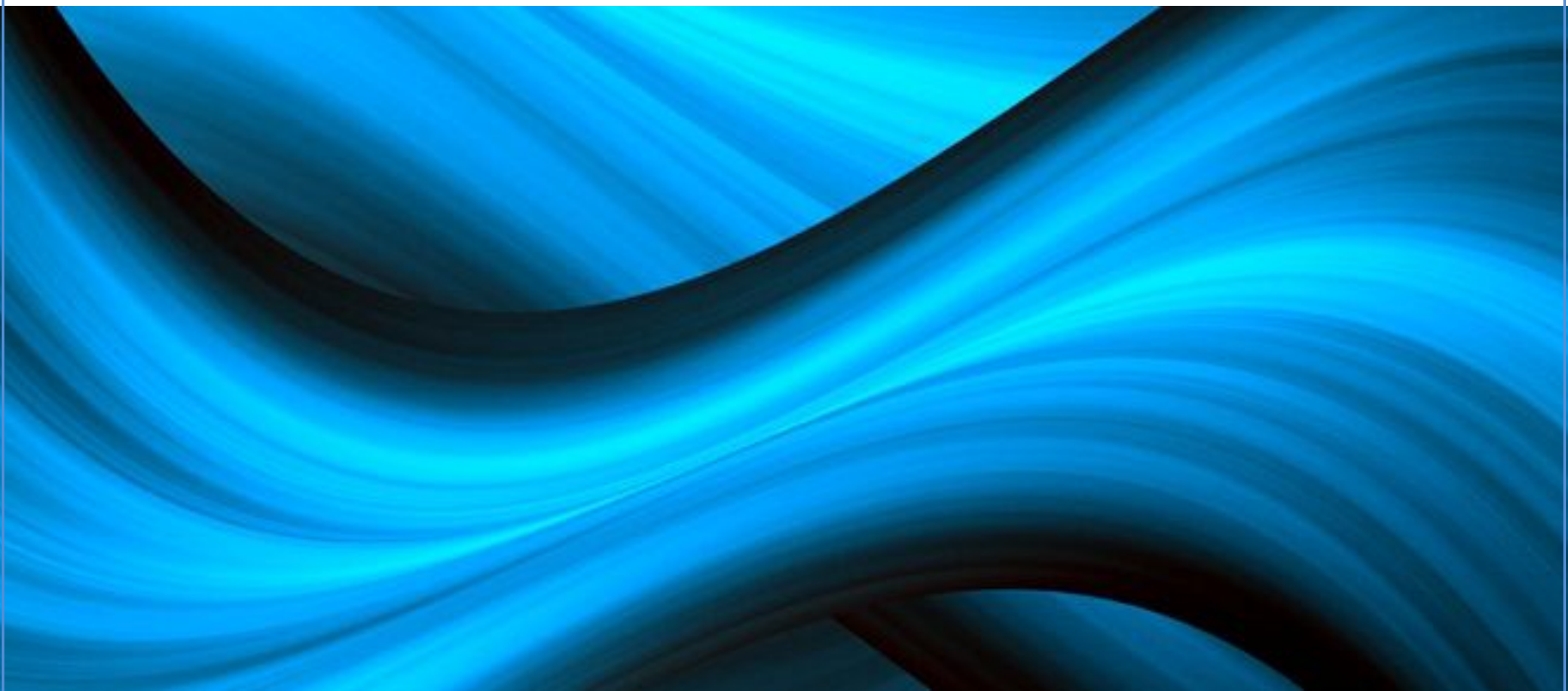

HAOTEC GROUP



Solar Module

**PERFECT INTERPRET
THE WONDERFUL OF SOLAR ENERGY**

www.hfsolar.net

COMPANY PROFILE

HAOTECH GROUP established in Hongkong since 2007, mainly for solar PV and led lighting products producing and global supply chain service. and speedy service, backed up by friendly customer service and a comprehensive guarantee.

Now we have **TWO SALES BRANCHES** in guangzhou and foshan, **4 WORKSHOPS** mainly in guangdong and zhejiang province in China and one **GSCS** branch in shenzhen.

Biggest advantages that we are powerful in resources, so that we can control the quality and cost.

We produce more than 200 kinds of products in solar PV and led lighting, selling to all over the world more than 20 countries and cities, the yearly sales amount is more than 100million.

We owe our success to a simple, but effective formula: good quality products and speedy service, backed up by friendly customer service and a comprehensive guarantee.

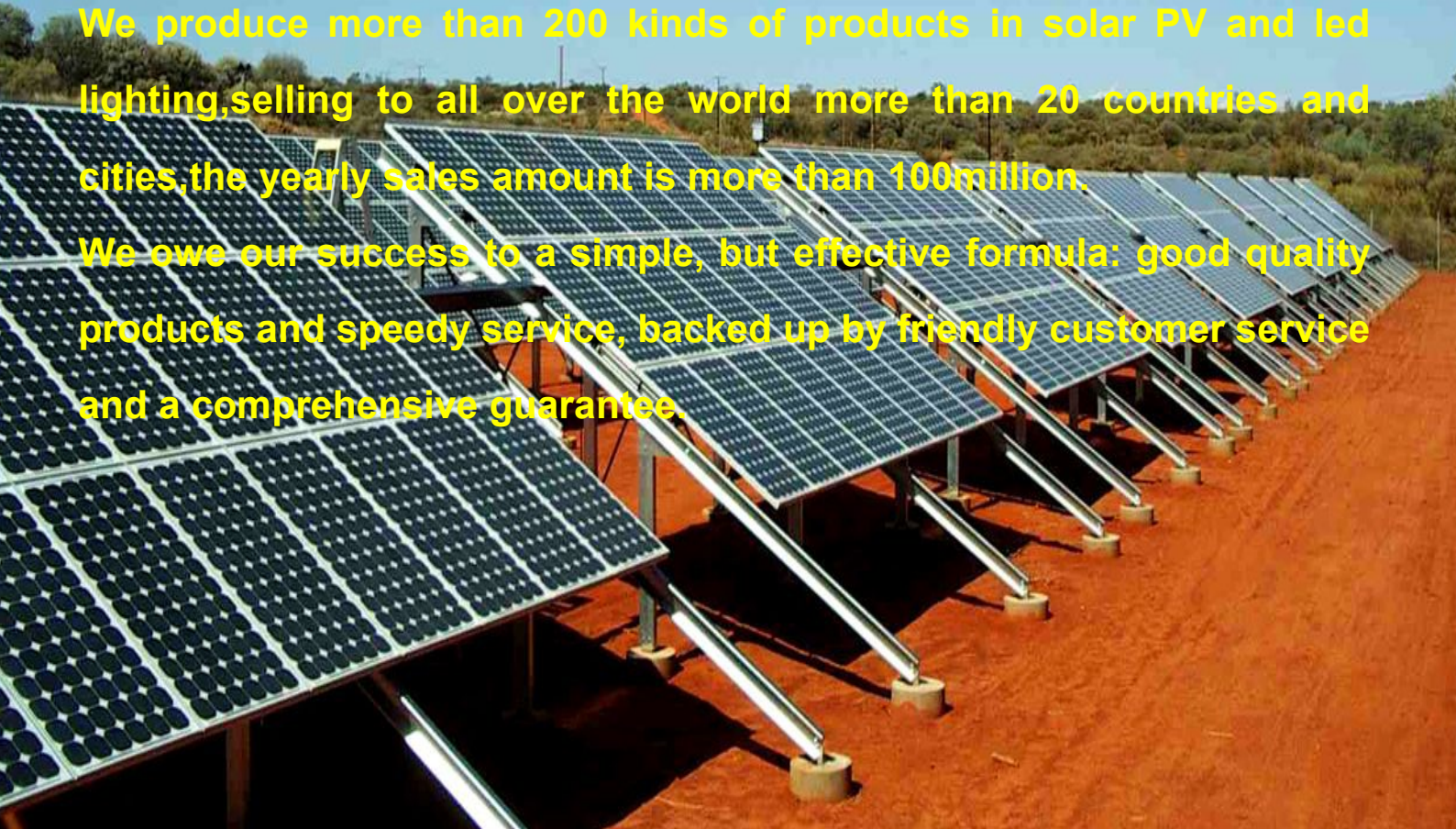

CONTENTS



Poly-Crystalline Solar modules..... P 1

Mono-Crystalline Solar modules.....P 2

HT-170Wp~200Wp-72P Mono-Crystalline Solar module.....P 3

HT-210Wp~250Wp-96P Mono-Crystalline Solar modules.....P 4

HT-210Wp~240Wp-60P Poly-Crystalline Solar modules..... .P 5

HT-240Wp~280Wp-72P Poly-Crystalline Solar modules..... ..P 6

HT-220Wp~250Wp-60M Mono-Crystalline Solar modules..... ..P 7

HT-260Wp~290Wp-72P Mono-Crystalline Solar modules..... ..P 8

Poly-Crystalline Solar modules

Model	Pma(W)	Vm(V)	Im(A)	Voc(V)	Isc(A)	Cells Efficiency	No.of Cell (pcs)	Cell Size (mm)	Module Size(mm)	Kg	Quantity For 40HQ (Pcs)
HT-S10P	10W	17.28	0.61	21.24	0.66	14.2%	36	52*39	360*260*25	1.40	14000
HT-S20P	20W	17.28	1.16	21.24	1.35	14.0%		78*52	540*360*25	2.20	8000
HT-S25P	25W	17.30	1.45	21.30	1.68	15.6%		156*31.2	650*360*30	3.00	5000
HT-S30P	30W	17.30	1.16	21.70	1.26	15.0%		156*39	780*360*30	5.00	4500
HT-S35P	35W	17.30	2.02	21.50	2.22	14.9%		156*39	780*360*30	5.00	4500
HT-S40P	40W	17.35	2.30	21.60	2.55	15.3%		156*52	670*540*30	5.50	3800
HT-S45P	45W	17.30	2.87	21.40	2.87	15.4%		156*52	670*540*30	5.50	3800
HT-S55P	55W	17.64	2.84	21.42	3.20	15.2%		36	156*78	780*670*30	6.00
HT-S60P	60W	17.64	3.41	21.42	3.85	14.6%					
HT-S65P	65W	17.30	3.78	21.50	4.16	14.9%					
HT-S70P	70W	17.70	3.96	21.90	4.20	16.2%	40	156*52	670*595*30	5.00	3500
HT-S50P	50W	19.20	2.61	23.90	2.86	15.9%		156*78	860*670*30	7.80	2000
HT-S75P	75W	19.30	4.03	23.90	4.23	15.7%	36	156*117	1130*670*30	10.50	1600
HT-S80P	80W	19.30	3.89	23.70	4.33	15.0%					
HT-S85P	85W	17.30	4.91	21.20	5.45	15.3%					
HT-S90P	90W	17.45	5.21	21.26	5.68	16.8%					
HT-S95P	95W	17.56	5.49	21.55	5.95	17.9%					
HT-S100P	100W	17.50	5.78	21.45	6.21	18.4%					
HT-S105P	105W	17.10	6.15	21.20	6.69	15.5%					
HT-S110P	110W	17.10	6.43	21.10	7.49	16.2%					
HT-S115P	115W	17.30	6.73	21.20	7.75	15.8%					
HT-S120P	120W	17.64	6.98	21.30	7.95	15.1%					
HT-S125P	125W	17.50	7.14	21.30	8.26	15.4%					
HT-S130P	130W	17.50	7.45	21.70	8.32	15.6%					
HT-S135P	135W	17.64	7.72	21.80	8.41	17.2%					
HT-S140P	140W	17.70	7.95	21.90	8.53	16.2%					
HT-S145P	145W	17.88	8.24	21.60	8.61	17.1%	48	156*156	1340*992*35	13.50	1000
HT-S150P	150W	24.30	6.17	28.50	7.55	14.7%					
HT-S155P	155W	24.30	6.17	29.30	7.78	14.9%					
HT-S160P	160W	24.10	6.38	29.40	7.76	14.5%					
HT-S165P	165W	24.40	6.58	29.50	7.93	15.3%					
HT-S170P	170W	24.50	6.76	29.30	8.11	15.2%					
HT-S175P	175W	24.60	6.94	29.40	8.12	15.6%					
HT-S180P	180W	24.40	7.15	29.60	8.39	16.5%	54	156*156	1482*992*40	15.00	860
HT-S185P	185W	24.30	7.32	29.40	8.87	15.9%					
HT-S190P	190W	24.50	7.52	29.80	8.89	17.4%					
HT-S190P	190W	27.54	7.19	33.10	5.58	16.7%					
HT-S195P	195W	27.30	7.21	33.20	7.89	17.4%					
HT-S200P	200W	27.32	7.39	33.40	7.99	17.5%					
HT-S205P	205W	27.33	7.51	33.45	8.12	17.6%					
HT-S210P	210W	27.40	7.70	33.45	8.35	17.3%					

Mono-Crystalline Solar modules

Model	Pma(W)	Vm(V)	Im(A)	Voc(V)	Isc(A)	Cells Efficiency	No.of Cell (pcs)	Cell Size (mm)	Module Size(mm)	Kg	Quantity For 40HQ (Pcs)
HT-S10M	10W	17.28	0.63	21.30	0.89	16.4%	36	62.5*31.25	330*306*25	1.40	14000
HT-S15M	15W	17.28	1.13	21.50	0.93	16.3%		62.5*41.67	330*425*25	2.20	8000
HT-S20M	20W	17.30	1.14	21.60	1.29	16.5%		125*31.25	640*306*25	2.50	6000
HT-S25M	25W	17.30	1.43	21.50	1.61	16.5%		125*41.67	541*450*25	3.00	5000
HT-S30M	30W	17.30	1.72	21.40	1.94	16.4%			541*450*28	3.20	4500
HT-S35M	35W	17.30	2.01	21.60	2.26	16.5%		125*62.5	541*630*28	5.00	4200
HT-S40M	40W	17.35	2.29	21.60	2.58	16.7%					
HT-S45M	45W	17.30	2.57	21.65	2.91	16.7%					
HT-S50M	50W	17.50	2.86	21.60	3.36	16.5%		125*75	541*755*30	5.20	3800
HT-S55M	55W	17.64	2.84	21.42	3.20	15.2%		72	125*41.67	541*830*30	6.00
HT-S60M	60W	17.64	3.41	21.42	3.85	15.9%					
HT-S65M	65W	17.30	3.78	21.50	4.16	16.2%	36	156*78	780*670*30	7.00	2600
HT-S70M	70W	17.70	3.96	21.90	4.20	16.2%					
HT-S75M	75W	17.20	4.36	21.30	4.88	16.5%					
HT-S80M	80W	17.20	4.65	21.50	5.07	16.7%	36	125*125	1195*541*30	7.80	1800
HT-S85M	85W	17.60	4.82	21.60	5.29	16.6%					
HT-S90M	90W	17.60	5.14	21.40	5.37	16.8%					
HT-S95M	95W	17.40	5.39	21.55	5.69	17.9%					
HT-S100M	100W	19.60	5.14	24.60	5.37	17.8%	40	125*125	1320*541*30	11.50	1500
HT-S105M	105W	19.60	5.36	24.60	5.62	17.8%					
HT-S110M	110W	17.10	6.43	21.10	7.49	16.2%	36	156*156	1482*670*35	13.50	1200
HT-S115M	115W	17.10	6.73	21.20	7.75	16.8%					
HT-S120M	120W	17.30	6.98	21.30	7.95	17.1%					
HT-S125M	125W	17.50	7.14	21.30	8.26	16.4%					
HT-S130M	130W	17.50	7.45	21.70	8.32	16.6%					
HT-S135M	135W	17.50	7.72	21.80	8.41	17.2%					
HT-S140M	140W	17.70	7.95	21.90	8.53	16.2%					
HT-S145M	145W	17.80	8.24	21.60	8.61	17.1%					
HT-S140M	140W	33.80	4.14	42.80	4.69	16.6%	72	125*125	1580*808*35	16.00	860
HT-S145M	145W	33.80	4.31	42.90	4.82	16.5%					
HT-S150M	150W	34.20	4.41	43.60	4.97	16.7%					
HT-S155M	155W	34.90	4.49	43.65	5.01	16.8%					
HT-S160M	160W	35.10	4.57	43.67	4.95	16.6%					
HT-S165M	165W	35.10	4.71	43.70	5.14	16.4%					
HT-S180M	180W	24.80	7.26	29.50	8.39	16.5%	48	1320*992*35	13.20	900	
HT-S185M	185W	24.80	7.47	29.40	8.87	15.9%					
HT-S190M	190W	25.00	7.62	29.80	8.89	17.4%					
HT-S195M	195W	27.10	7.20	33.10	7.89	16.5%	54	156*156	1482*992*40	15.00	850
HT-S200M	200W	27.30	7.33	33.65	7.99	17.2%					
HT-S205M	205W	27.30	7.51	33.64	8.12	16.1%					
HT-S210M	210W	27.40	7.62	33.60	8.35	15.9%					
HT-S215M	251W	27.78	7.74	33.54	8.54	17.6%					



KEY FEATURES

- 72(6×12)high efficiency mono-crystalline silicon cells
- Stable electrical performance
- High conversion rate
- Excellent low-light performance
- Easy installation
- Anodized aluminum alloy, beautiful and durable
- 25 years module power output warranty

HT-170Wp~200Wp-72P Mono-Crystalline Solar modules

Date(HTM)	S170M	S175M	S180M	S185M	S190M	S195M	S200M
Maximum power (Pmax)	170Wp	175Wp	180Wp	185Wp	190Wp	195Wp	200Wp
Open circuit voltage (Voc)	43.90	44.00	44.50	44.60	44.65	44.70	44.80
Short circuit current (Isc)	5.25	5.40	5.45	5.49	5.58	5.75	5.89
Voltage at Pmax (Vmp)	35.50	35.60	36.00	36.30	36.60	36.80	36.90
Current at Pmax (Imp)	4.79	4.92	5.00	5.10	5.19	5.30	5.42
Average Efficiency	16.15%	16.48%	16.83%	17.29%	17.79%	18.05%	18.51%
Maximum system voltage	DC 1000V						
Voc Temperature Coefficient	-0.36%/°C						
Isc Temperature Coefficient	0.033%/°C						
Pmax Temperature Coefficient	-0.44%/°C						
Cell type	72 cells, 6×12, Mono-Crystalline Silicon cell, (125mm x 125mm)						
Junction Box	IP65-3 Bypass diodes serviceable						
Type of Connector	MC4-OR compatible connector						
Wire	Length:900mm,Cross area:1×4mm ²						
Front Cover	3.2 mm thick,low iron tempered glass						
Back Cover	TPT (Tedlar-PET-Tedlar)						
Encapsulant	EVA						
Frame	Anodized aluminum alloy						
Dimensions	1580×808×35 mm						
Weight	15.5 kg						
Max Impact Force	2,400Pa/5,400Pa						
Max Load	60m/s (240kg/sq.m)						
Oprating Temperature	-40°C~+85°C						
STC (Standard text conditions): irradiance 1000W/m ² , Module Temperature 25°C , Air Mass 1.5							
Power Tolerance: ±3%							
Fully comply with CE,TUV,ISO,CEC and CQC							

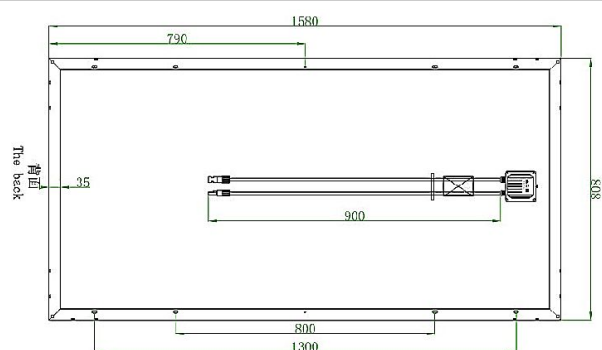
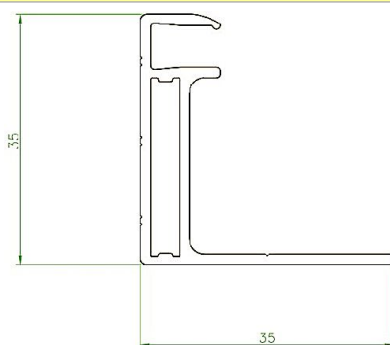

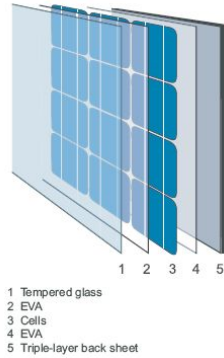
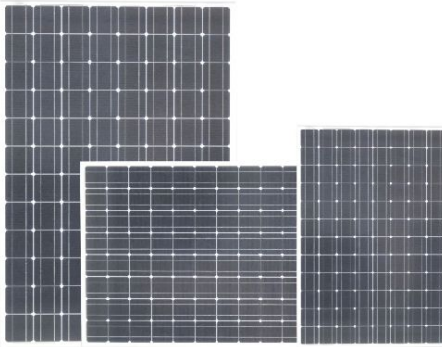

KEY FEATURES

- 96(8×12)high efficiency mono-crystalline silicon cell
- Stable electrical performance
- High conversion rate
- Excellent low-light performance
- Easy installation
- Anodized aluminum alloy, beautiful and durable
- 25 years module power output warranty

HT-210Wp~250Wp-96P Mono-Crystalline Solar modules

Date(HTM)	S210M	S215M	S220M	S225M	S230M	S235M	S240M	S245M	S250M
Maximum power (Pmax)	210Wp	215Wp	220Wp	225Wp	230Wp	235Wp	240Wp	245Wp	250Wp
Open circuit voltage (Voc)	57.6	57.6	57.8	57.9	58.3	58.7	58.8	59	59.1
Short circuit current (Isc)	4.85	4.87	4.93	5.05	5.16	5.29	5.33	5.58	5.69
Voltage at Pmax (Vmp)	48	48	48.1	48.3	48.4	48.5	48.7	49	48.7
Current at Pmax (Imp)	4.4	4.48	4.57	4.68	4.76	4.87	4.95	5.04	5.1
Average Efficiency	14.79%	15.13%	15.42%	15.83%	16.12%	16.52%	16.83%	17.22%	17.53%
Maximum system voltage	DC 1000V								
Voc Temperature Coefficient	-0.36%/°C								
Isc Temperature Coefficient	0.033%/°C								
Pmax Temperature Coefficient	-0.44%/°C								
Cell type	96 cells, 8×12, Mono-Crystalline Silicon cell, (125mm x 125mm)								
Junction Box	IP65-3 Bypass diodes serviceable								
Type of Connector	MC4-OR compatible connector								
Wire	Length:900mm,Cross area:1×4mm ²								
Front Cover	3.2 mm thick,low iron tempered glass								
Back Cover	TPT (Tedlar-PET-Tedlar)								
Encapsulant	EVA								
Frame	Anodized aluminum alloy								
Dimensions	1580×1065×50 mm								
Weight	22.5 kg								
Max Impact Force	2,400Pa/5,400Pa								
Max Load	60m/s (240kg/sq.m)								
Oprating Temperature	-40°C~+85°C								

STC (Standard test conditions): irradiance 1000W/m², Module Temperature 25°C , Air Mass 1.5

Power Tolerance: ±3%

Fully comply with CE,TUV,ISO,CEC and CQC

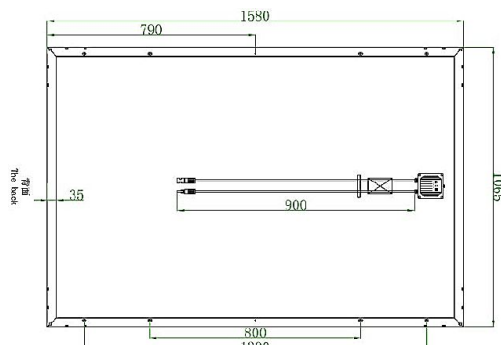
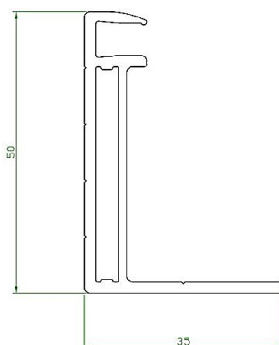

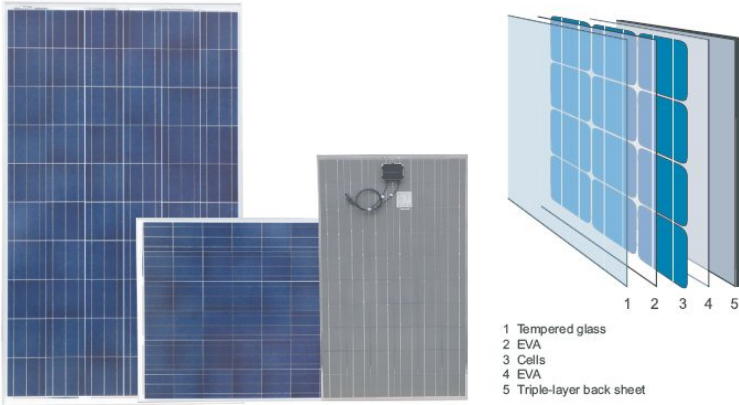

KEY FEATURES

- 60(6×10)high efficiency poly-crystalline silicon cell
- Stable electrical performance
- High conversion rate
- Excellent low-light performance
- Easy installation
- Anodized aluminum alloy, beautiful and durable
- 25 years module power output warranty

HT-210Wp~240Wp-60P Poly-Crystalline Solar modules

Date(HTP)	S210P	S215P	S220P	S225P	S230P	S235P	S240P
Maximum power (Pmax)	210Wp	215Wp	220Wp	225Wp	230Wp	235Wp	240Wp
Open circuit voltage (Voc)	36.4	36.7	36.8	36.8	37	37.1	37.1
Short circuit current (Isc)	7.86	7.93	7.99	8.09	8.18	8.25	8.35
Voltage at Pmax (Vmp)	29.7	29.7	29.8	29.9	30.1	30.5	30.6
Current at Pmax (Imp)	7.07	7.25	7.38	7.53	7.67	7.82	7.87
Average Efficiency	14.83%	14.72%	15.07%	15.41%	15.75%	16.09%	16.44%
Maximum system voltage	DC 1000V						
Voc Temperature Coefficient	-0.36%/°C						
Isc Temperature Coefficient	0.033%/°C						
Pmax Temperature Coefficient	-0.44%/°C						
Cell type	60 cells, 6×10,Poly-Crystalline Silicon cell, (156mm x 156mm)						
Junction Box	IP65-3 Bypass diodes serviceable						
Type of Connector	MC4-OR compatible connector						
Wire	Length:900mm,Cross area:1×4mm ²						
Front Cover	3.2 mm thick,low iron tempered glass						
Back Cover	TPT (Tedlar-PET-Tedlar)						
Encapsulant	EVA						
Frame	Anodized aluminum alloy						
Dimensions	1650×992×45/50 mm						
Weight	19.5kg/21.5kg						
Max Impact Force	2,400Pa/5,400Pa						
Max Load	60m/s (240kg/sq.m)						
Operating Temperature	-40°C~+85°C						
STC (Standard test conditions): irradiance 1000W/m ² , Module Temperature 25°C , Air Mass 1.5							
Power Tolerance: ±3%							
Fully comply with CE,TUV,ISO,CEC and CQC							

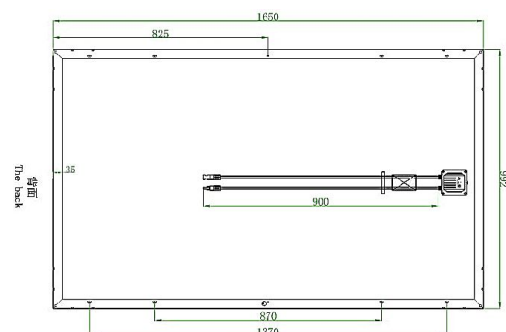
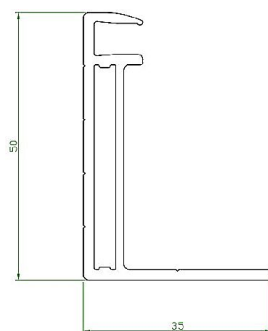
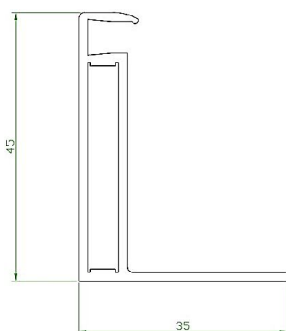

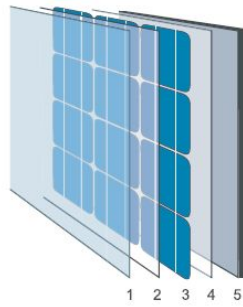

1 Tempered glass
2 EVA
3 Cells
4 EVA
5 Triple-layer back sheet

KEY FEATURES

- 72(6×12)high efficiency poly-crystalline silicon cell
- Stable electrical performance
- High conversion rate
- Excellent low-light performance
- Easy installation
- Anodized aluminum alloy, beautiful and durable
- 25 years module power output warranty

HT-240Wp~280Wp-72P Poly-Crystalline Solar modules

Date(HTP)	S240P	S245P	S250P	S255P	S260P	S265P	S270P	S275P	S280P
Maximum power (Pmax)	240Wp	245Wp	250Wp	255Wp	260Wp	265Wp	270Wp	275Wp	280Wp
Open circuit voltage (Voc)	43.60	43.70	43.80	43.90	44.00	42.20	44.50	44.60	44.80
Short circuit current (Isc)	7.65	7.76	7.87	7.99	8.09	8.15	8.21	8.28	8.33
Voltage at Pmax (Vmp)	35.00	35.00	35.00	35.05	35.10	35.10	35.12	35.20	35.20
Current at Pmax (Imp)	6.86	7.01	7.15	7.28	7.41	7.55	7.69	7.82	7.95
Average Efficiency	13.92%	14.21%	14.49%	14.75%	17.84%	15.12%	15.41%	15.69%	15.98%
Maximum system voltage	DC 1000V								
Voc Temperature Coefficient	-0.36%/°C								
Isc Temperature Coefficient	0.033%/°C								
Pmax Temperature Coefficient	-0.44%/°C								
Cell type	72 cells, 6×12,Poly-Crystalline Silicon cell, (156mm x 156mm)								
Junction Box	IP65-3 Bypass diodes serviceable								
Type of Connector	MC4-OR compatible connector								
Wire	Length:900mm,Cross area:1×4mm ²								
Front Cover	3.2 mm thick,low iron tempered glass								
Back Cover	TPT (Tedlar-PET-Tedlar)								
Encapsulant	EVA								
Frame	Anodized aluminum alloy								
Dimensions	1957×992×50 mm								
Weight	24kg								
Max Impact Force	2,400Pa/5,400Pa								
Max Load	60m/s (240kg/sq.m)								
Operating Temperature	-40°C~+85°C								
STC (Standard test conditions): irradiance 1000W/m ² , Module Temperature 25°C , Air Mass 1.5									
Power Tolerance: ±3%									
Fully comply with CE,TUV,ISO,CEC and CQC									

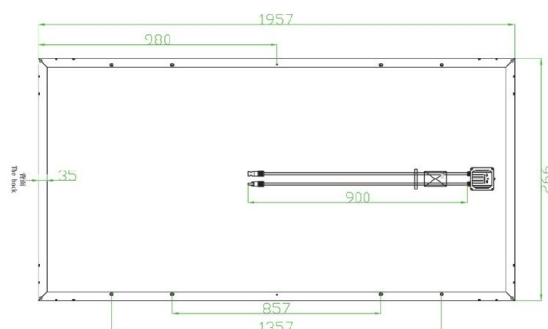
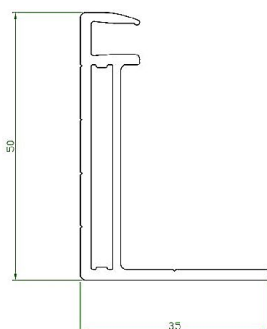

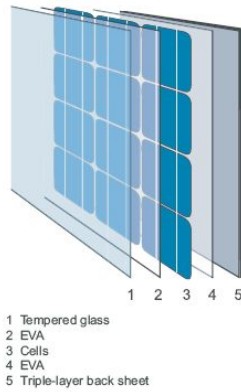
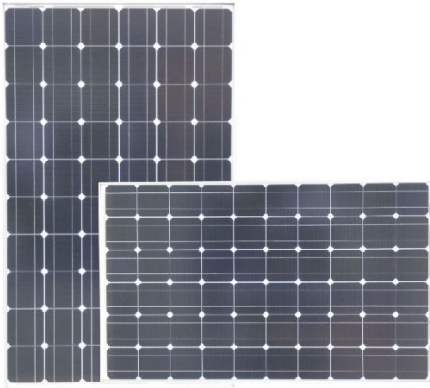

KEY FEATURES

- . 60 (6×10)high efficiency mono-crystalline silicon cell
- . Stable electrical performance
- . High conversion rate
- . Excellent low-light performance
- . Easy installation
- . Anodized aluminum alloy, beautiful and durable
- . 25 years module power output warranty

HT-220Wp~250Wp-60M Mono-Crystalline Solar modules

Date(HTM)	S220M	S225M	S230M	S235M	S240M	S245M	S250M
Maximum power (Pmax)	220Wp	225Wp	230Wp	235Wp	240Wp	245Wp	250Wp
Open circuit voltage (Voc)	36.63	36.77	36.81	36.88	37.01	37.10	37.10
Short circuit current (Isc)	8.21	8.35	8.41	8.56	8.62	8.69	8.78
Voltage at Pmax (Vmp)	29.70	29.90	30.26	30.51	30.77	30.85	30.90
Current at Pmax (Imp)	7.41	7.53	7.66	7.70	7.81	7.94	8.07
Average Efficiency	15.50%	15.90%	16.20%	16.60%	16.90%	17.30%	17.50%
Maximum system voltage	DC 1000V						
Voc Temperature Coefficient	-0.36%/°C						
Isc Temperature Coefficient	0.033%/°C						
Pmax Temperature Coefficient	-0.44%/°C						
Cell type	60 cells, 6×10, Mono-Crystalline Silicon cell, (156mm x 156mm)						
Junction Box	IP65-3 Bypass diodes serviceable						
Type of Connector	MC4-OR compatible connector						
Wire	Length:900mm,Cross area:1×4mm ²						
Front Cover	3.2 mm thick,low iron tempered glass						
Back Cover	TPT (Tedlar-PET-Tedlar)						
Encapsulant	EVA						
Frame	Anodized aluminum alloy						
Dimensions	1650×990×45/50 mm						
Weight	19.5kg/21.5kg						
Max Impact Force	2,400Pa/5,400Pa						
Max Load	60m/s (240kg/sq.m)						
Oprating Temperature	-40°C~+85°C						

STC (Standard test conditions): irradiance 1000W/m², Module Temperature 25°C , Air Mass 1.5

Power Tolerance: ±3%

Fully comply with CE,TUV,ISO,CEC and CQC

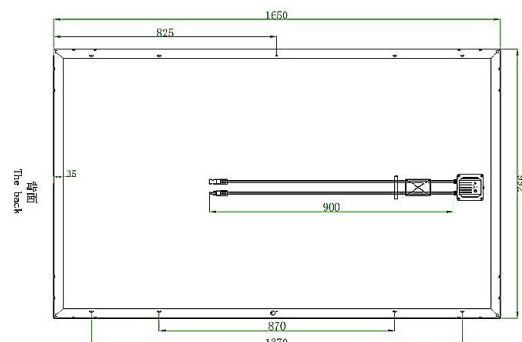
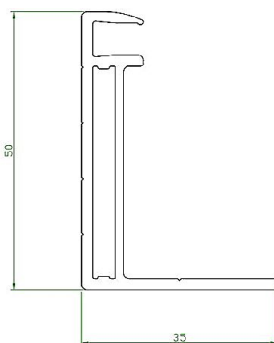
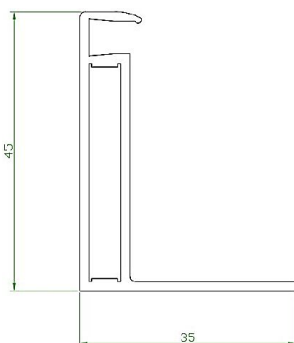

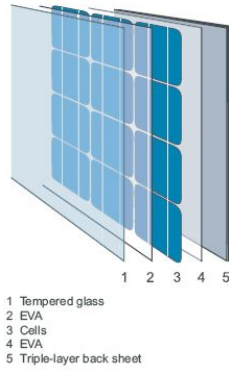
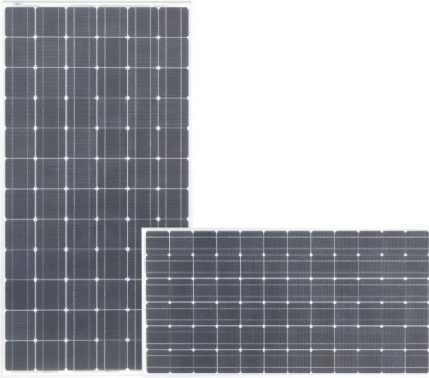

KEY FEATURES

- 72(6×12)high efficiency Mono-crystalline silicon cell
- Stable electrical performance
- High conversion rate
- Excellent low-light performance
- Easy installation
- Anodized aluminum alloy, beautiful and durable
- 25 years module power output warranty

HT-260Wp~290Wp-72P Mono-Crystalline Solar modules

Date(HTM)	S260M	S265M	S270M	S275M	S280M	S285M	S290M
Maximum power (Pmax)	260Wp	265Wp	270Wp	275Wp	280Wp	285Wp	290Wp
Open circuit voltage (Voc)	43.90	44.00	44.50	44.60	44.65	44.70	44.80
Short circuit current (Isc)	8.19	8.33	8.39	8.41	8.55	8.63	8.78
Voltage at Pmax (Vmp)	35.80	35.00	36.00	36.30	36.60	36.80	36.90
Current at Pmax (Imp)	7.27	7.41	7.50	7.58	7.65	7.75	7.86
Average Efficiency	15.29%	15.59%	15.66%	16.17%	16.47%	16.59%	16.79%
Maximum system voltage	DC 1000V						
Voc Temperature Coefficient	-0.36%/°C						
Isc Temperature Coefficient	0.033%/°C						
Pmax Temperature Coefficient	-0.44%/°C						
Cell type	72 cells, 6×12, Mono-Crystalline Silicon cell, (156mm x 156mm)						
Junction Box	IP65-3 Bypass diodes serviceable						
Type of Connector	MC4-OR compatible connector						
Wire	Length:900mm,Cross area:1×4mm ²						
Front Cover	3.2 mm thick,low iron tempered glass						
Back Cover	TPT (Tedlar-PET-Tedlar)						
Encapsulant	EVA						
Frame	Anodized aluminum alloy						
Dimensions	1957×992×50 mm						
Weight	24kg						
Max Impact Force	2,400Pa/5,400Pa						
Max Load	60m/s (240kg/sq.m)						
Operating Temperature	-40°C~+85°C						
STC (Standard test conditions): irradiance 1000W/m ² , Module Temperature 25°C , Air Mass 1.5							
Power Tolerance: ±3%							
Fully comply with CE,TUV,ISO,CEC and CQC							

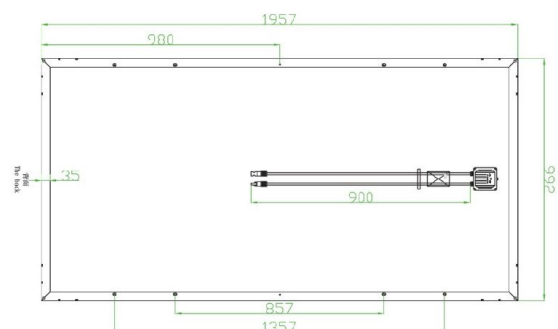
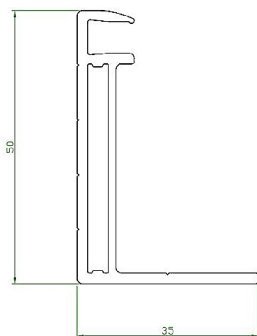



HONG KONG HAOTECH LIMITED

Solar Energy & LED lights

<http://www.hfsolar.net>

Guangdong Haotech New Energy technology Co.,Ltd

HONGKONG ADDRESS:18/F ON HONG COMM BLDG 145 HENNESSY RD
WANCHAI HK

CHINA GUANGZHOU ADDRESS 1:RM. 19A,YUXING GE,GUOLONG
BUILDING,NO. 276,HUANSHIZHONG LU,YUEXIU DISTRICT,GUANGZHOU,
CHINA

CHINA GUANGZHOU ADDRESS 2:NO.1,Guangzhou science city,LuoGang
district,Guangzhou.CN.

Postal Code : 510000
Tel : 86-020-29815670
E-mail: haotechsolarled.louisa@aliyun.com
skype:louisa.tang1988